

# SIMAC<sup>®</sup> Solutions

Control of flashing side marker lights

# The Ermax solution is called SIMAC®

Compliant to legislation with unique flexibility

## Control of flashing side marker lights ECE 48 since November 2017

With the ECE regulation No. 48 (Changes series 06) it is prescribed that the side marker lights must flash synchronously and simultaneously with the direction indicators (in the tail light) – this is mandatory for vehicles – class 03 and 04 - being homologated after November 18 2017.

Ermax SIMAC® ensures the compliance with the legislation  
– we will advise the optimal application

**SIMAC: Side marker lights Control**

## SIMAC "Snap-In" module

- Ideal for any application, even in retrofit
- The flexible solution in order to keep an existing kit configuration almost unchanged

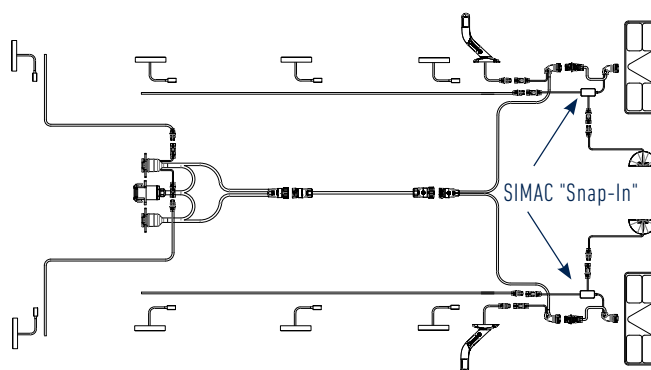

## SIMAC integrated in the junction box

- Mounted in a secure and protected position with ideal plug connection to the system
- The best possible solution especially when 3 & 2 function lights are being used

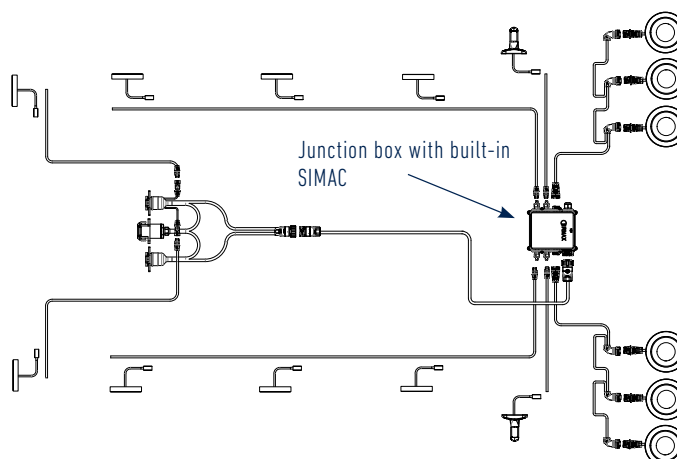

## ERMAX side marker lights



- Standard mounting
- 2 LED diodes
- 4 mounting versions
- 4 cable versions
- IP69K rating



- Mounting without visible screws
- 2 LED diodes
- 4 mounting versions
- 3 cable versions
- IP69K rating

### SIMAC integrated in the rear cable

- Optimised design for easy mounting
- Ideal for the lean high-volume solution

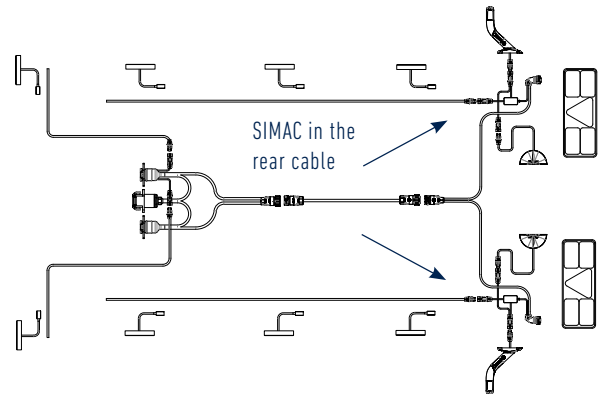
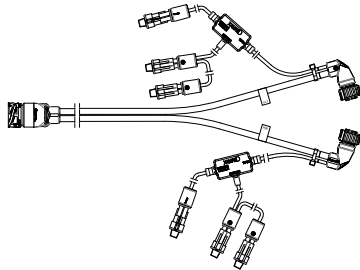

### SIMAC as adapter in the main cable

- Allows mounting of side cables from front to back
- Recommendable when a LED control box is used in the cable system

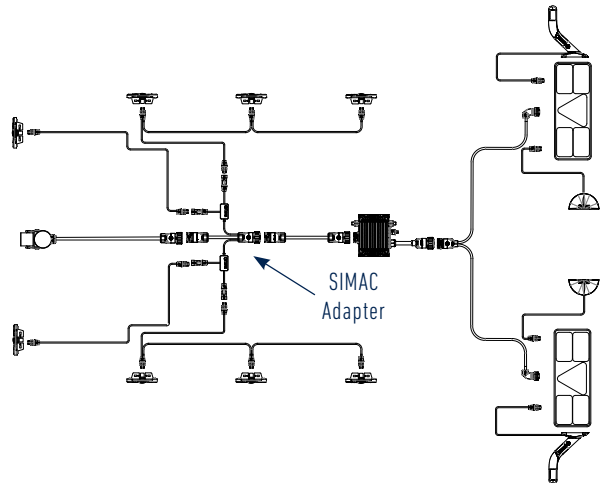
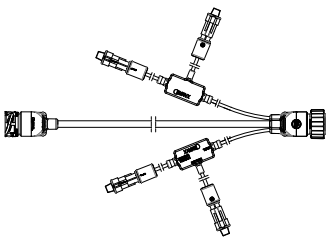

### SIMAC integrated in the tail light

- The easy and ideal solution without external modules
- No further parts or components needed



TM10 LED



TM11 LED

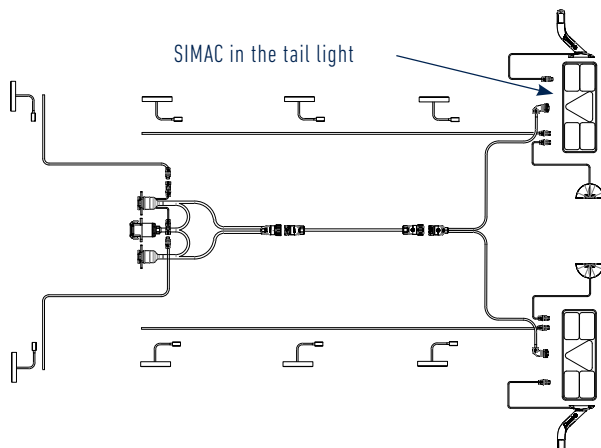

Brands of the BPW Group:



**ERMAX**®

**HBN-Teknik** A/S

**HESTAL**®

**idem**  
telematics

September 2018 - Version 1.0

 **ERMAX**®  
“Light Made Heavy Duty”

ERMAX A/S  
Vranderupvej 2 • DK-6000 Kolding  
Bjerringbrovej 116 • DK-2610 Rødovre  
Tlf. +45 3969 6800  
[www.ermax.dk](http://www.ermax.dk)